

# Custom Made Doors

## Fitting Instructions



## CONTENT

---

# 02

Surveying

# 02

Equipment & Tools  
Required

# 02

Pre-Installation Checks

# 03

- Security Rated Doors
- Fixing options for security rated doors

# 04

- Requirements for Fire Rated Doors
- Internal fire rated doors

# 05

- External Fire Rated M2M+ doors instructions
- External fire rated and security rated

# 05

Standard M2M+

# 06

- Flood Defense doors
- Classical Doorset

# 07

Installation Instructions for Single Doors with Adjusters

# 08

Installation Instructions for Double Doors with Adjusters

# 09

Installation Instructions for Single Doors Without Adjusters

# 10

Installation Instructions for Double Doors Without Adjusters

## Surveying

---

Accurate surveying is important for correct installation. Please take measurements from the top, middle and bottom of the width and use the smallest measurement. Repeat for the height.

If providing Latham's Group with the structural opening measurements, we will reduce the overall manufactured frame size by 10mm in the width and 5mm in the height, this is to allow tolerance for the installation.

It is the client's responsibility to ensure the opening is fire and security rated, square, clean and accessible, prior to installation.

## Equipment & Tools Required

---

- Masonry drill bits and standard drill bits
- Pencil or marker pen
- Spirit level
- Measuring tape
- Fixings to comply with the minimum fixing standards
- Tools to install fixings, i.e. cordless/corded drills
- Mastic or similar filler

## Pre-Installation Checks

---

- Open supplied package and check contents against delivery note
- Ensure the area is clear of all obstructions
- Make sure the structural opening is solid and can achieve the fire and security rating of the door to be installed
- Check that the door frame supplied will fit into the opening
- Check that it is safe to drill around the opening

## SECURITY RATED DOORS

When installing security rated doors, the client must be fully satisfied that the structure around the aperture is more secure or equivalent to the doorset rating.

LCR2, LCR3, LCR4 doorsets are LPCB certified to LPS 1175 SR2, SR3 and SR4, respectively. To ensure that the installation complies with the accreditation, follow one of the minimum fixing standards below.

The minimum fixing standards (below) assume installation direct into substrate not via intermediate substrate, such as plasterboard. The perimeter of the door should be made good, using mastic or similar.

## FIXING OPTIONS SECURITY RATED DOORS

Door Type	Substrate						
	Brick, Block & Concrete			Steel			
Door Type	Min Qty	Size, Grade & Min Bolt Diameter	Min Length	Min Qty	Size & Grade	Min Length	Min Steel Thickness
LCR2	24	M8 8.8 Grade 8mm Dia	60-150mm	24	M8 8.8 Grade +	30mm	3mm
	16		16mm	16	5.5 Tek Screw	16mm	3mm
	7		16mm	7	6.3 Tek Screw	16mm	3mm
	15	M6 A2 Screw	16mm	15	M6 A2 Screw	16mm	3mm
	7	M6 10.9 Screw	16mm	7	M6 10.9 Screw	16mm	3mm
	4	M8 A2 Screw	16mm	4	M8 A2 Screw	16mm	3mm
	4	M8 10.9 Screw	16mm	4	M8 10.9 Screw	16mm	3mm
	24	Hilti Type Fixing 7mm Dia	60-150mm		6.3 Tek Screw		
LCR3	24	M8 8.8 Grade 8mm Dia	60-150mm	24	M8 8.8 Grade +	30mm	3mm
	13	M8 A2 Screw	16mm	13	M8 A2 Screw	16mm	3mm
	8	M8 10.9 Screw	16mm	8	M8 10.9 Screw	16mm	3mm
	24	Hilti Type Fixing 7mm Dia	60-150mm		6.3 Tek Screw		
LCR4	22	M8 A2 Grade 8mm Dia	60-150mm	22	M8 A2 Grade 8mm Dia	30mm	5mm
	21	M8 10.9 Grade 8mm Dia	60-150mm	21	M8 10.9 Grade 8mm Dia	30mm	5mm
	21	M10 10.9 Grade 10mm Dia	60-150mm	21	M10 10.9 Grade 10mm Dia	30mm	5mm
	9	M10 12.9 Grade 10mm Dia	60-150mm	9	M10 12.9 Grade 10mm Dia	30mm	5mm
	9	M10 A2-70 Grade 10mm Dia	60-150mm	9	M10 A2-70 Grade 10mm Dia	30mm	5mm
	9	M12 8.8 Grade 12mm Dia	60-150mm	9	M12 8.8 Grade 12mm Dia	30mm	5mm
	9	M12 10.9 Grade 12mm Dia	60-150mm	9	M12 10.9 Grade 12mm Dia	30mm	5mm
	9	M12 12.9 Grade 12mm Dia	60-150mm	9	M12 12.9 Grade 12mm Dia	30mm	5mm

## FIRE RATED DOORS

Additional requirements for fire rated doors:

- Fixings to the main structural surround should comprise of steel screws of sufficient length to penetrate the main structure by a minimum of 30mm, although 120mm is recommended (plastic plugs can only be used if fully concealed within the structural opening substrate).
- All fixings and hardware must be steel (no plastic).
- Steel screws are to be inserted at a maximum of 500mm centres.
- Fixing clearing holes in the frame may be covered using steel or plastic bungs.
- Any packers or shims used during installation must be made from steel.
- Gaps between the structural opening and the frame should be sealed in accordance with the fire rated sealant used as per the manufacturer's specification
- On fire double doors, an overlap of 18mm covering the passive door leaf (anti-pry strip) is required.
- The passive door on double doors must be fixed top and bottom, and the active leaf must have a centre latch, as minimum.
- Wall must be of equal rating to door otherwise door takes wall rating.

## INTERNAL FIRE RATED DOORS

Additional requirements for fire rated doors:

- Fixings to the main structural surround should comprise of steel screws of sufficient length to penetrate the main structure by a minimum of 30mm, although 100mm is recommended (plastic plugs can only be used if fully concealed within the structural opening substrate).
- All fixings and hardware must be steel (no plastic).
- Steel screws are to be inserted at a maximum of 500mm centres.
- Fixing clearing holes in the frame must be covered using steel or plastic bungs.
- Any packers or shims used during installation must be made from steel.
- Gaps between the structural opening and the frame should be sealed in accordance with the fire rated sealant used as per the manufacturing specifications.
- The passive door on double doors must be fixed top and bottom, and the active leaf must have a centre latch, as minimum.

The maximum gaps allowed around a fire rated door are as follows:

For standard fire doors:

- 20, 19, 18, 17, 7, 8, 9, 10 = 7mm
- 1, 2, 3, 4, 5, 6 = 10mm
- 21, 22, 23, 24 = 5.5mm
- 16, 15, 14, 13, 12, 11 = 20mm

For security rated doors:

- 20, 19, 18, 17, 7, 8, 9, 10 = 6mm
- 1, 2, 3, 4, 5, 6 = 4.2mm
- 21, 22, 23, 24 = 5.6mm
- 16, 15, 14, 13, 12, 11 = 20mm

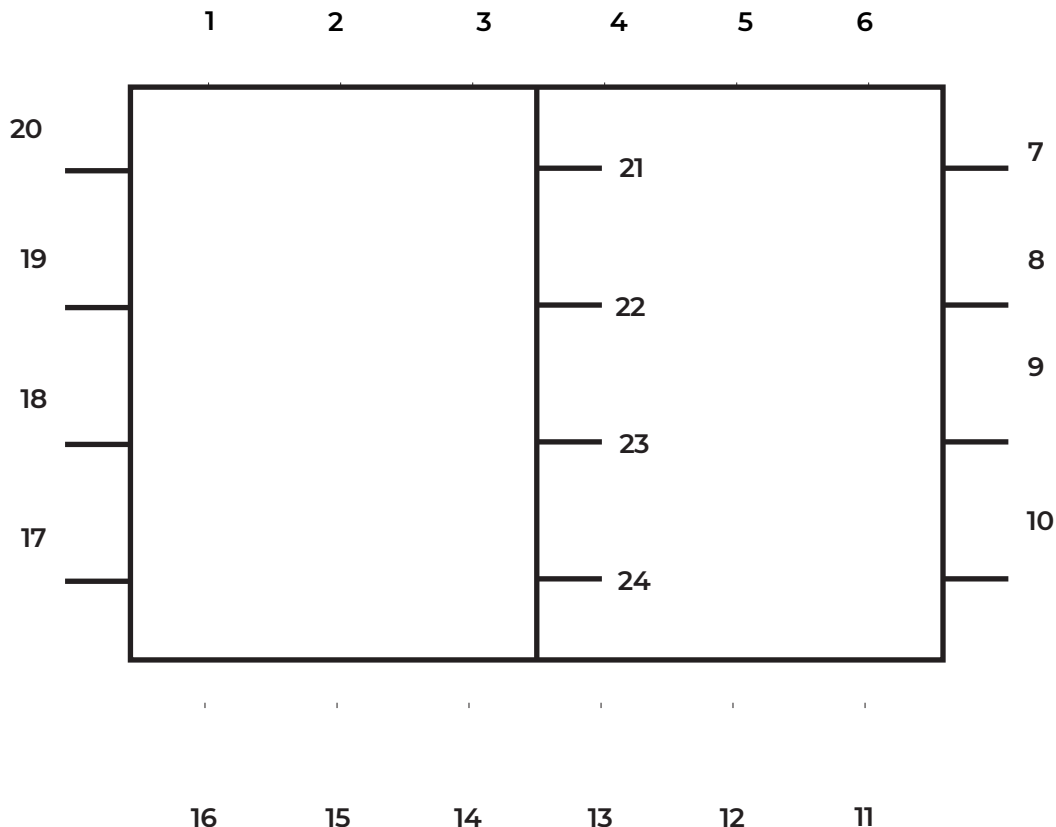

## EXTERNAL FIRE RATED DOORS

---

The maximum authorised clearance measurements for external fire rated door are as follows:

For single leaf door:

- Upper transom = 8.5mm
- On hinges side = 7.5mm
- On lock side = 10mm
- At the threshold = 16mm
- Central latch bolt = 14mm
- Dog bolts = 22mm

For double leaf door:

- Upper transom = 3mm
- On hinges side = 3.5mm
- On lock side = 3mm
- At the threshold = 11mm
- Central latch bolt = 8mm
- Dog bolts = 18mm

Maximum authorised clearance measurements with seven-point lock (HOOPLY) and with additional hinge at mid height

- Upper transom = 3.5mm
- On hinges side = 2mm
- On lock side = 4mm
- At the threshold = 8.7mm

## EXTERNAL FIRE AND SECURITY RATED

---

Maximum authorised clearance measurements

Upper Rail	3mm
On hinges side	6mm
On lock side for single leaf	2.5mm
On lock side for double leaves	6mm
At the threshold	4 mm

<b>Minimum engagement of the median latch bolt for single leaf</b>	<b>25.5mm</b>
<b>Minimum engagement of the median latch bolt for double leaves</b>	<b>10mm</b>

## STANDARD DOORSET

---

Minimum of 6 fixings on each post, top sill does not have to be fixed if not required. Fixings are 10 x 80 - 160mm dependent on structure.

HRD- C hilti screws.



## FLOOD DEFENCE DOORS

---

Additional requirements for flood defence doors:

- Apply SIKA primer along the bottom of the structural opening in the position the threshold will sit and approx. 1m vertically up on the structural substrate, the same width as the frame. After this, a bead of flood mastic needs to be applied along the bottom of the structural opening in line with the threshold position and then the door frame inserted onto this to create a seal
- A flood sealant must be applied around the perimeter of the door between the frame and substrate, internally and externally including the bottom sill
- When testing hardware, push the door firmly shut into the frame, raise the handle 45<sup>o</sup> to ensure the seal is fully compressed and latch engaged (where present) and insert the key into the cylinder and turn (where present). The door is locked if the handle does not move.

## SINGLE DOORS WITHOUT ADJUSTERS

1. Insert the door and frame into the opening, and open the door to 90°.
2. Place the spirit level parallel to the frame. If the head of the frame is not level, use packers to raise the lowest side of the frame to level.
3. Once the frame is aligned, fill the gaps between the frame and the structure with packers to centralise the door and even out the gaps around the frame.
4. Level up the front face of the hinge post, ensuring the top of the frame does not lean in or out of the opening.
5. Drill and insert fixings into top and bottom fixing holes, and place packers close to the fixings. Do not tighten the fixings.
6. Position frame centrally in opening, with hinge post vertical. Double check the door alignment with a spirit level, then tighten fixings.
7. Drill the rest of the holes on each post and insert middle fixings. Do not tighten the fixings.
8. Place packers between the frame and the wall, adjacent to fixings, then tighten fixings.
9. Use the same method to secure the top sill in position.
10. Close door leaf to test it in the frame. If the leading edge is too high, add packing towards the top edge of the hinge post. If it's too low, then reduce packing towards the top edge.
11. Once adjustments are made, drill and insert fixings into lock post. Do not tighten the fixings.
12. Insert packers between the frame and wall fixing, then tighten fixings. Do not over pack between the frame and the wall.
13. Test the door hardware and operation. Any panic hardware must have the opening force measured and recorded in the operation and maintenance manual.
14. Fit the bottom sill (if present). Level up with shims so it is parallel with the bottom of the door leaf, then drill and fit to floor.
15. Mastic seal around the door frame and bottom sill (inside and outside), as required.
16. Plug the fixing holes in the frame with bungs.
17. Re-check operation of the doorset.

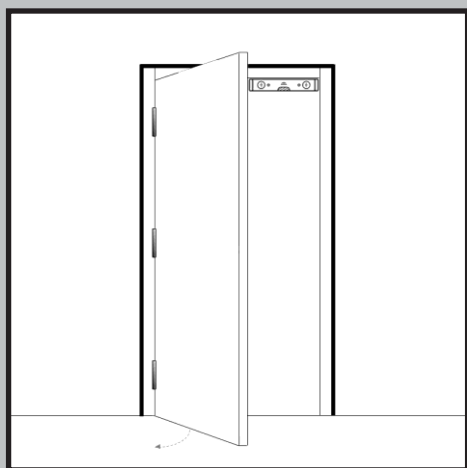

Steps 1-4

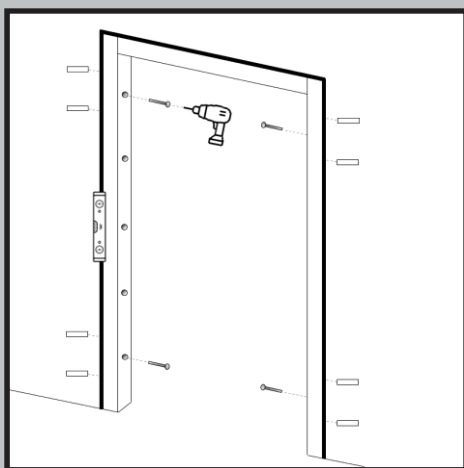

Steps 5-6

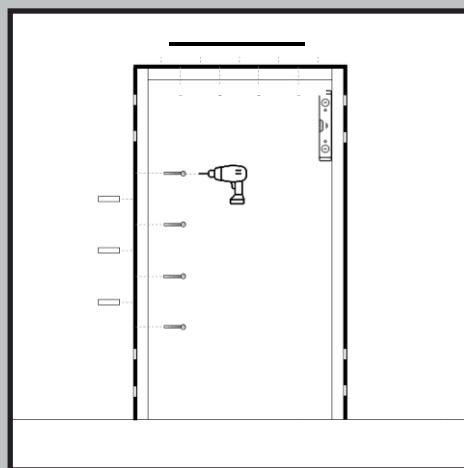

Steps 7-9

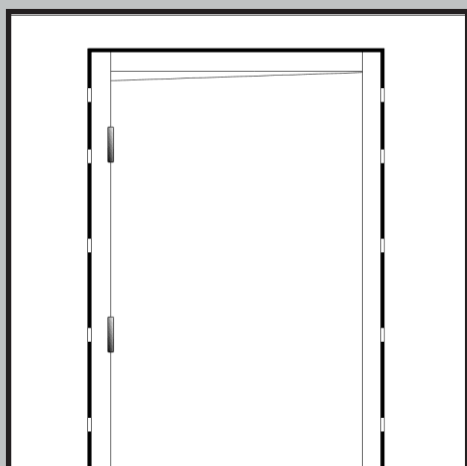

Step 10

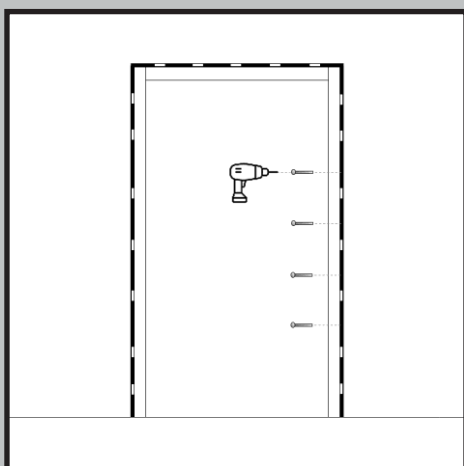

Steps 11-13

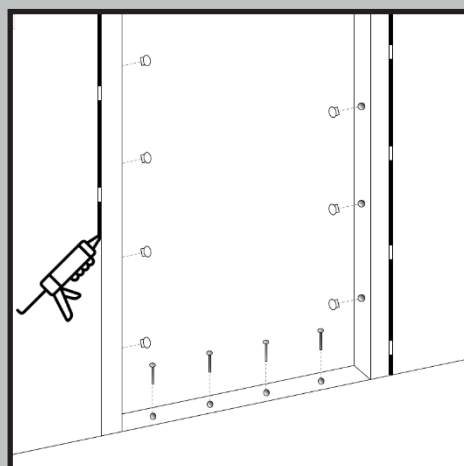

Steps 14-17

## DOUBLE DOORS WITHOUT ADJUSTERS

1. Assemble the door frame using fixing blocks and screws, then insert the frame into the opening.
2. Place the spirit level parallel to the frame. If the head of the frame is not level, use packers to raise the lowest side of the frame to level.
3. Once the frame is aligned, fill the gaps between the frame and the structure with packers to centralise the door and even out the gaps around the frame.
4. Level up the front face of the first hinge post, so the frame does not lean in or out of the opening.
5. Drill and insert fixings into top and bottom fixing holes. If the doors are heavy, add one or two fixings to the middle of each post as well. Place packers close to the fixings. Do not tighten the fixings.
6. Position frame centrally in opening, with the first hinge post vertical. Double check the door alignment with a spirit level, then tighten fixings.
7. Hang the doors on the frame, then close the doors to check that they shut correctly and are hanging level, and test the door hardware.
8. If the doors bind at the top, remove some of the packing from both sides at the top of the frame and tighten the fixings. If the doors are binding at the bottom, remove some of the packing from the bottom.
9. Once the doors are positioned and working satisfactorily, drill the rest of the holes on the hinge posts and insert fixings. Do not tighten the fixings.
10. Place packers between the frame and the wall, adjacent to each of the fixings, then tighten fixings. Do not over pack between the frame and the wall.
11. Use the same method to secure the top sill in position.
12. Test the door hardware and operation. Any panic hardware must have the opening force measured and recorded in the operation and maintenance manual.
13. Fit the bottom sill (if present). Level up with shims so it is parallel with the bottom of the door leaf, then drill and fit to floor.
14. Mastic seal around the door frame and bottom sill (inside and outside), as required.
15. Plug the fixing holes in the frame with bungs.
16. Re-check operation of the doorset.

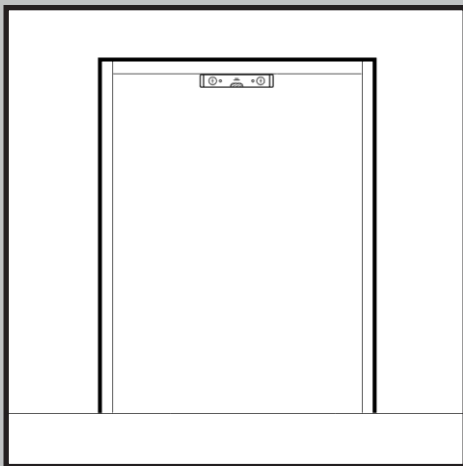

Steps 1-4

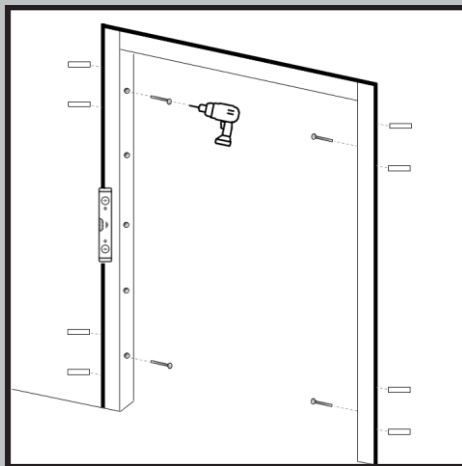

Steps 5-6

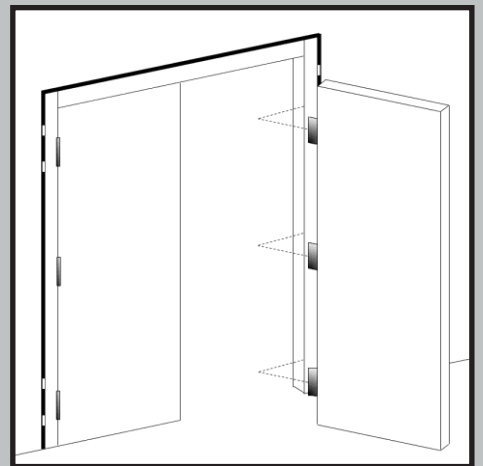

Step 7

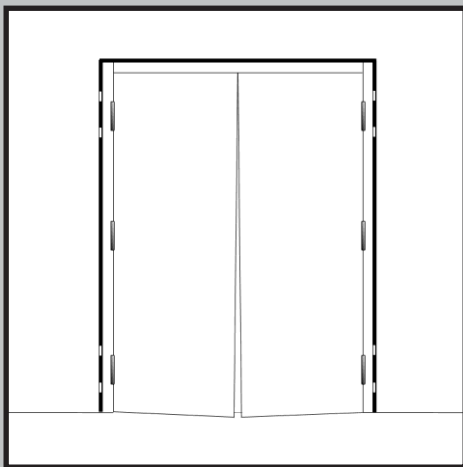

Step 8

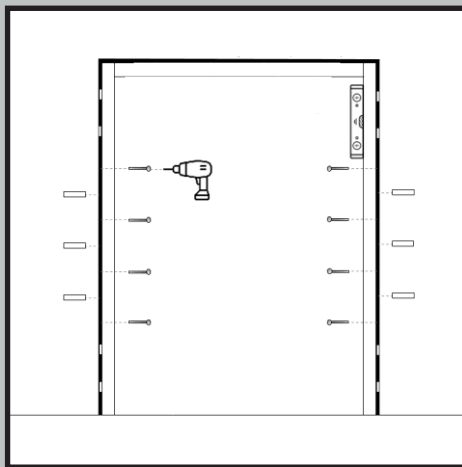

Steps 9-11

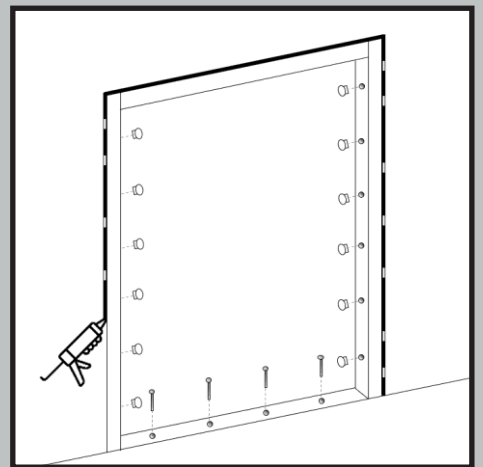

Steps 12-16

## SINGLE DOORS WITH ADJUSTERS

1. Insert the door and frame into the opening, and open the door to 90°, using packers underneath the door leaf to level the frame in the opening.
2. Place the spirit level parallel to the frame. If the head of the frame is not level, use packers to raise the lowest side of the frame to level.
3. Once the frame is aligned, screw the adjusters through the tapped holes using the hex tool supplied, ensuring the door is central in the opening. Adjusters must be arranged using one or more of the following patterns:

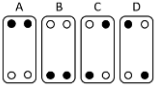

4. Level up the front face of the hinge post, ensuring the top of the frame does not lean in or out of the opening.
5. Using the hex tool supplied, fasten the top adjusters, then the bottom adjusters, and finally the middle adjusters. Care must be taken not to distort the frame by over-tightening the adjusters.
6. Close door leaf to test it in the frame. If the leading edge is too high, loosen the adjusters at the top edge of the hinge post. If it's too low, then tighten the adjusters towards the top edge.
7. Once adjustments are made, drill and insert fixings down both vertical posts. Do not tighten the fixings.
8. Double check the door alignment with a spirit level, then tighten fixings.
9. Test the door hardware and operation. Any panic hardware must have the opening force measured and recorded in the operation and maintenance manual.
10. Fit the bottom sill (if present). Level up with shims so it is parallel with the bottom of the door leaf, then drill and fit to floor.
11. Mastic seal around the door frame and bottom sill (inside and outside), as required.
12. Plug the fixing holes in the frame with bungs.
13. Re-check operation of the doorset.

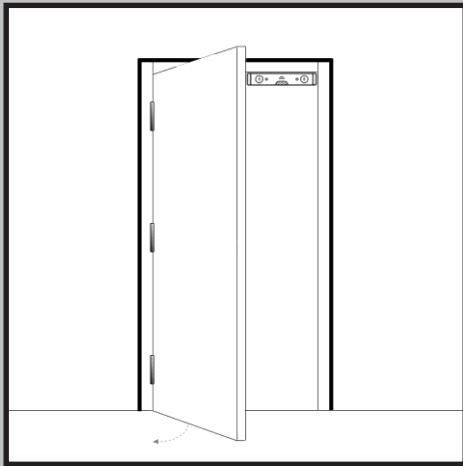

Steps 1-2

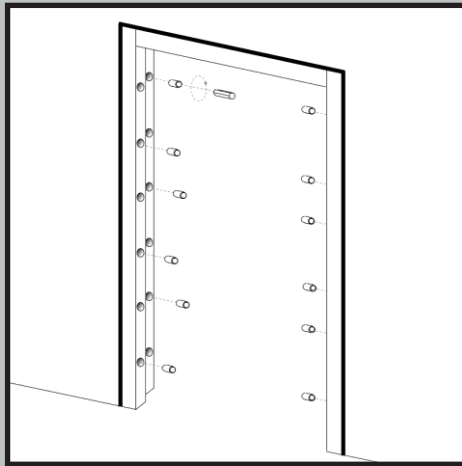

Steps 3-5

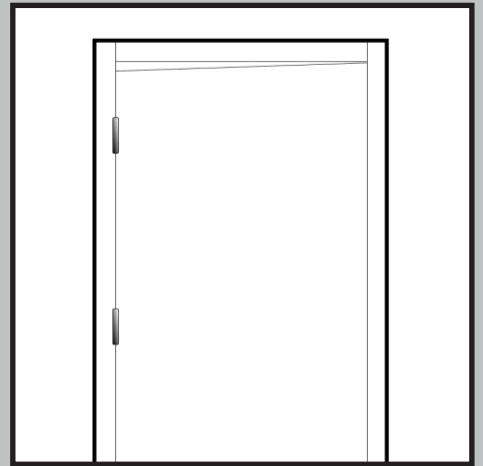

Step 6

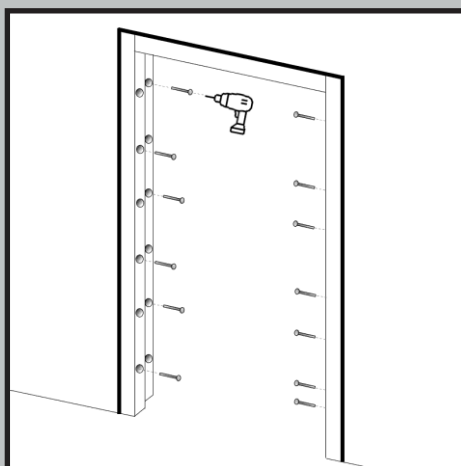

Steps 7-9

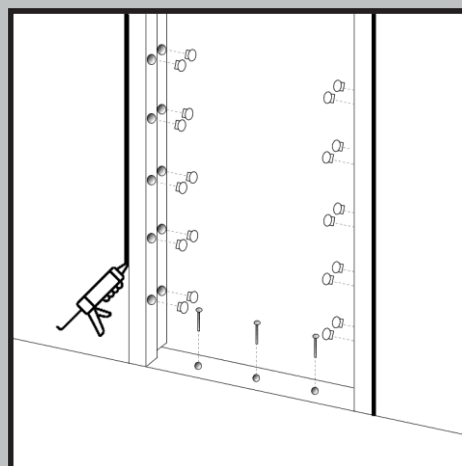

Steps 10-13

## DOUBLE DOORS WITH ADJUSTERS

1. Assemble the door frame using fixing blocks and screws, then insert the frame into the opening.
2. Place the spirit level parallel to the frame. If the head of the frame is not level, use packers to raise the lowest side of the frame to level.
3. Screw the adjusters through the tapped holes using the hex tool supplied, ensuring the door is central in the opening. Adjusters must be arranged using one or more of the following patterns:

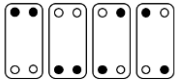

4. Level up the front face of the first hinge post, ensuring the frame does not lean in or out of the opening.
5. Drill and insert fixings into top and bottom fixing holes. If the doors are heavy, add one or two fixings to the middle of each post as well. Place packers close to the fixings. Do not tighten the fixings.
6. Position frame centrally in opening, with the first hinge post vertical. Double check the door alignment with a spirit level, then tighten fixings.
7. Hang the doors on the frame, then close the doors to check that they shut correctly and are hanging level, and test the door hardware.
8. If the doors bind at the top, loosen the adjusters on both sides at the top of the frame. If the doors are binding at the bottom, loosen the adjusters at the bottom.
9. Once adjustments are made, drill and insert fixings on all posts. Do not tighten the fixings.
10. Double check the door alignment with a spirit level, then tighten fixings.
11. Test the door hardware and operation. Any panic hardware must have the opening force measured and recorded in the operation and maintenance manual.
12. Fit the bottom sill (if present). Level up with shims so it is parallel with the bottom of the door leaf, then drill and fit to floor.
13. Mastic seal around the door frame and bottom sill (inside and outside), as required.
14. Plug the fixing holes in the frame with bungs.
15. Re-check operation of the doorset.

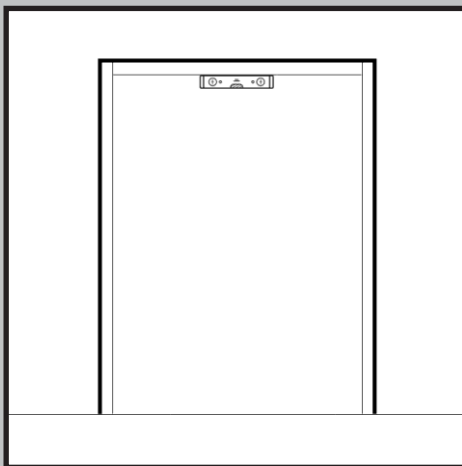

Steps 1-2

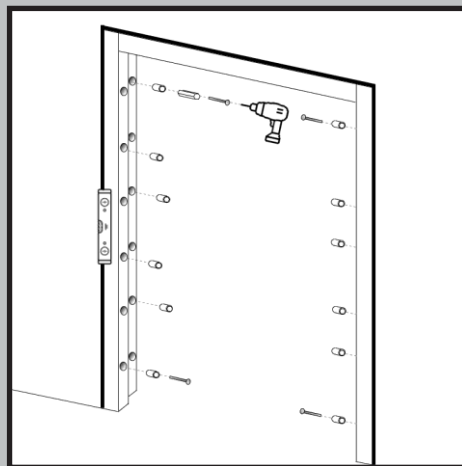

Steps 3-5

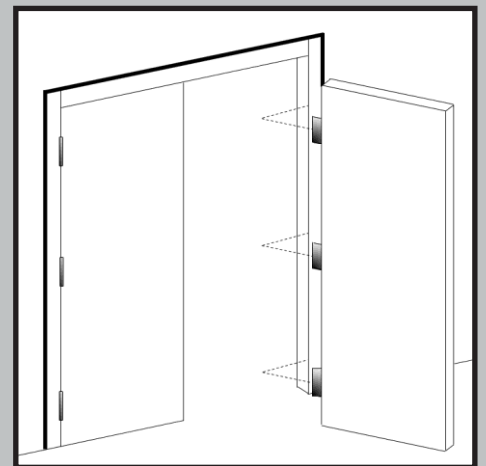

Step 6

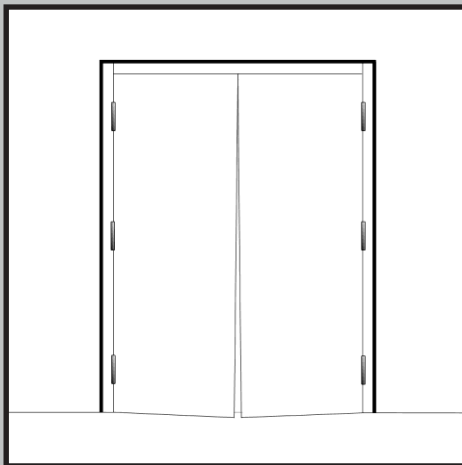

Step 7

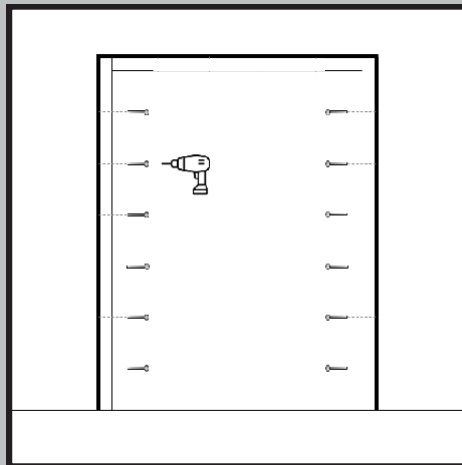

Steps 8-10

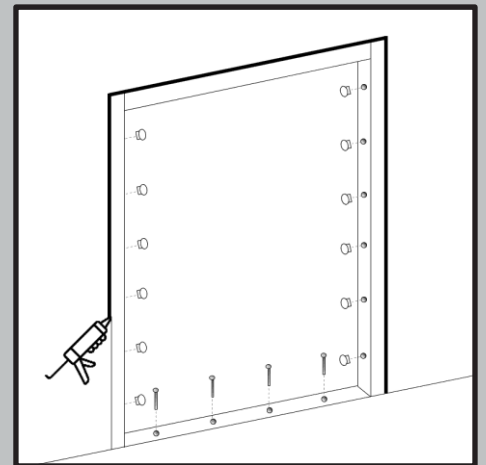

Steps 11-14



# **LATHAM'S** STEEL SECURITY DOORSETS

+44 (0)1384 22050  
[sales@lathamssteeldoors.co.uk](mailto:sales@lathamssteeldoors.co.uk)

45-37 Hainge Road  
Tividale  
Oldbury  
B69 2NY  
United Kingdom

[www.lathamssteeldoors.co.uk](http://www.lathamssteeldoors.co.uk)

